





NOTE

XX TYPE

General Notes

- Elevations are shown from exterior unless otherwise noted
- Anchor/wall fastener – Location, spacing and quantity to be determined per design pressure requirements by structural engineer and/or certified test drawings

	
	
	
	
	2021. 00. 00.
	DESCRIPTION
REV.	v2

PROJECT
—

ITEM NO.
—

PRODUCT NAME
ESS70 SD

QTY
1

VIEW
EXTERIOR

SCALE
—

DRAWING NO. ISSUE

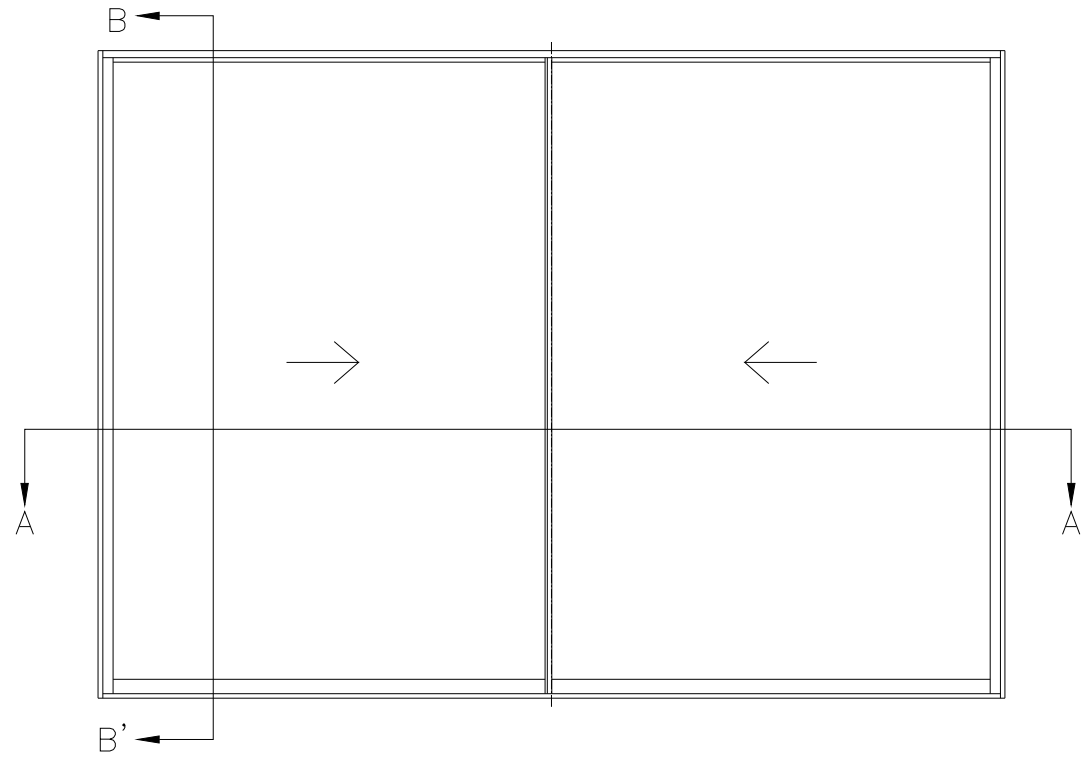

 ELEVATION
SCALE : 1/30

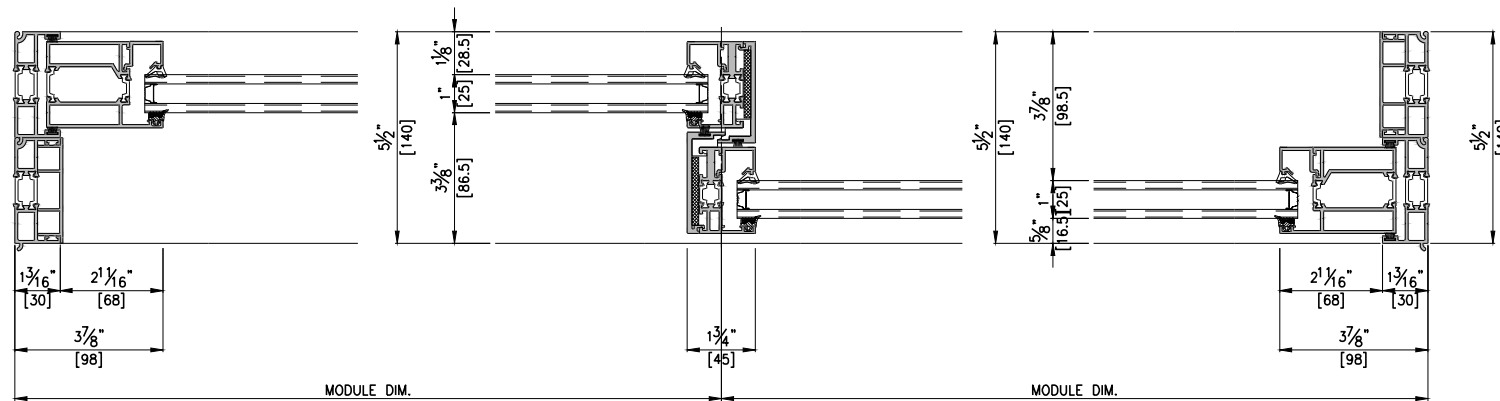

 HORIZONTAL SECTION DETAIL A-A'
SCALE : 1/5

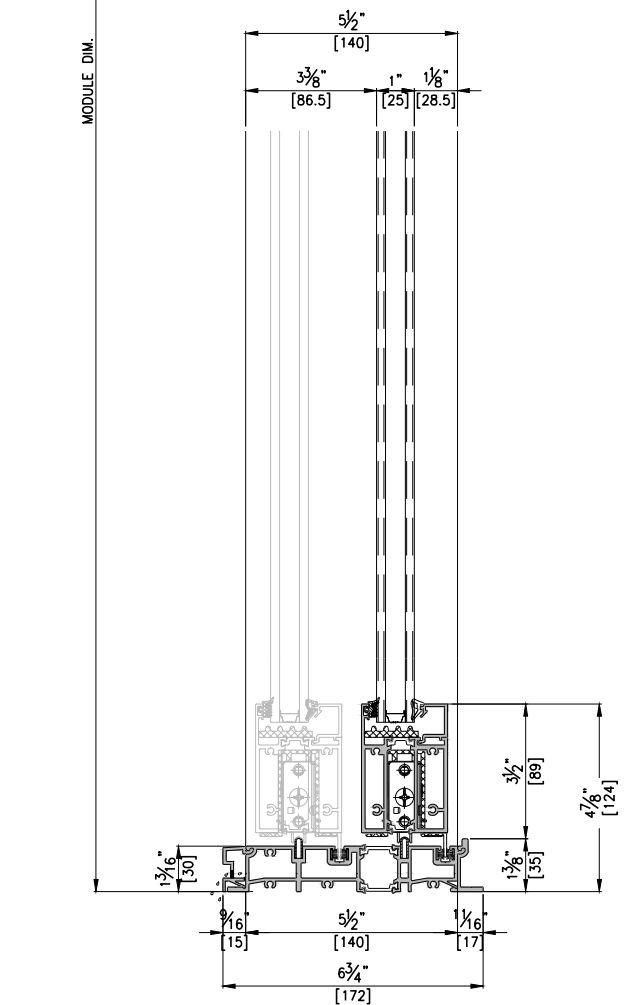
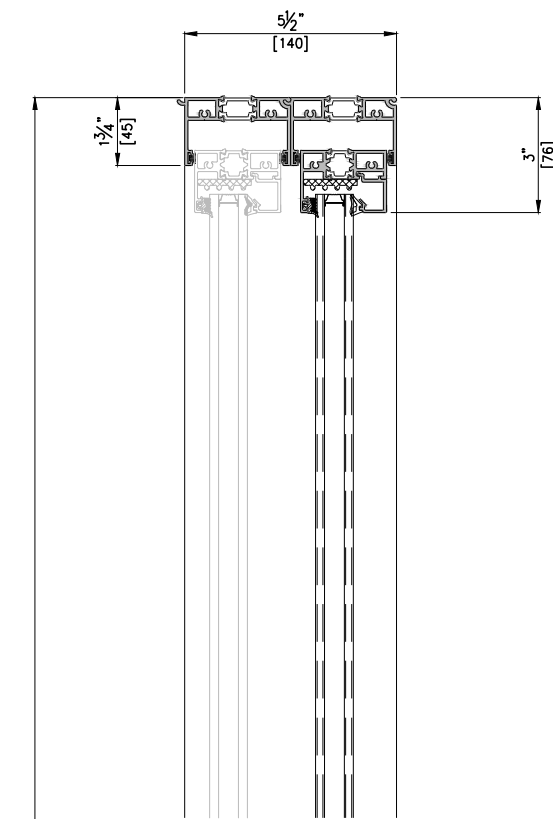

 VERTICAL SECTION DETAIL B-B'
SCALE : 1/5