

NOTE
X TYPE
44mm

- General Notes
- Elevations are shown from exterior unless otherwise noted
 - Anchor/wall fastener – Location, spacing and quantity to be determined per design pressure requirements by structural engineer and/or certified test drawings

△			
△			
△			
△			
△			
0			
	2021. 00. 00.		
REV.	DESCRIPTION		
v.3			

PROJECT	-		
ITEM NO.	-		
PRODUCT NAME	EDS75 OW W/S WITH SILL		
QTY	1		
VIEW	EXTERIOR		
SCALE	-		
DRAWING NO.		ISSUE	

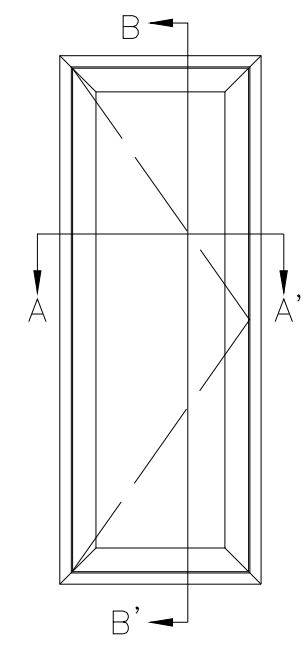

ELEVATION
SCALE: 1/30

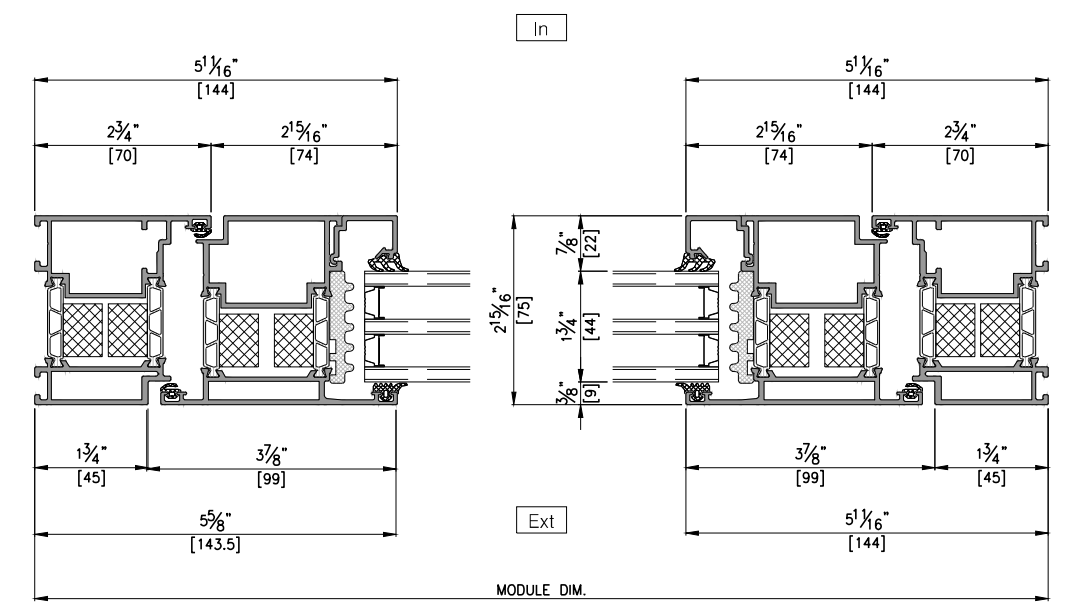

HORIZONTAL SECTION DETAIL A-A'
SCALE: 1/3

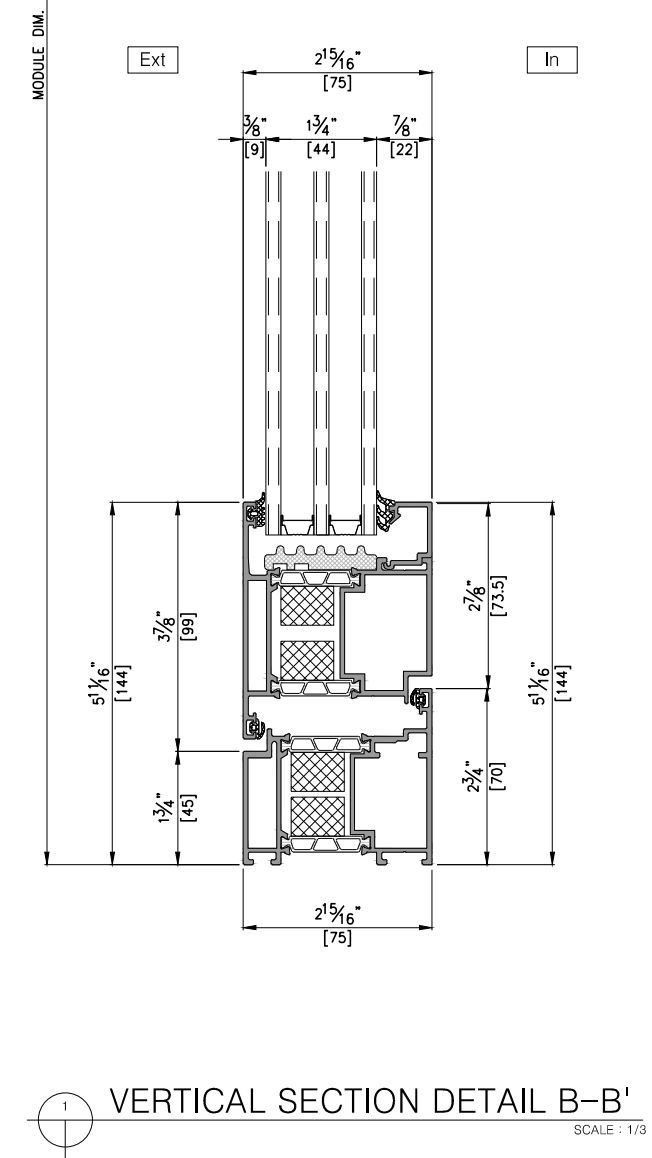
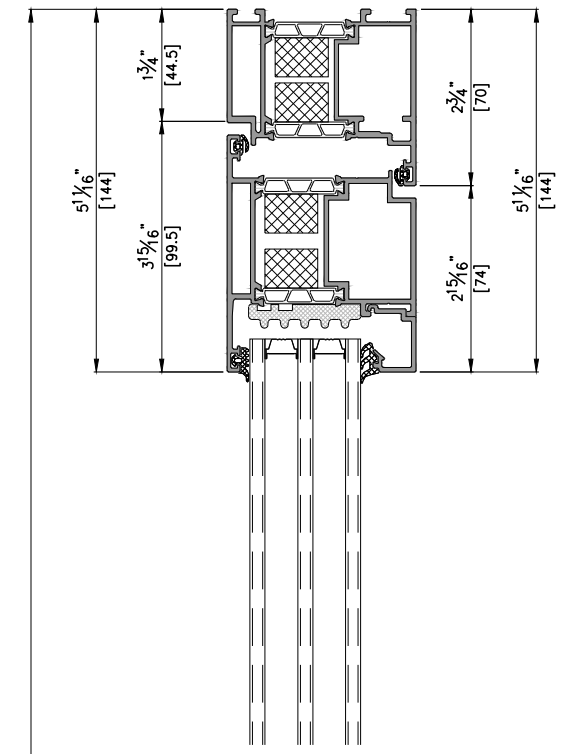

VERTICAL SECTION DETAIL B-B'
SCALE: 1/3