

ELEVATION
SCALE: 1/30

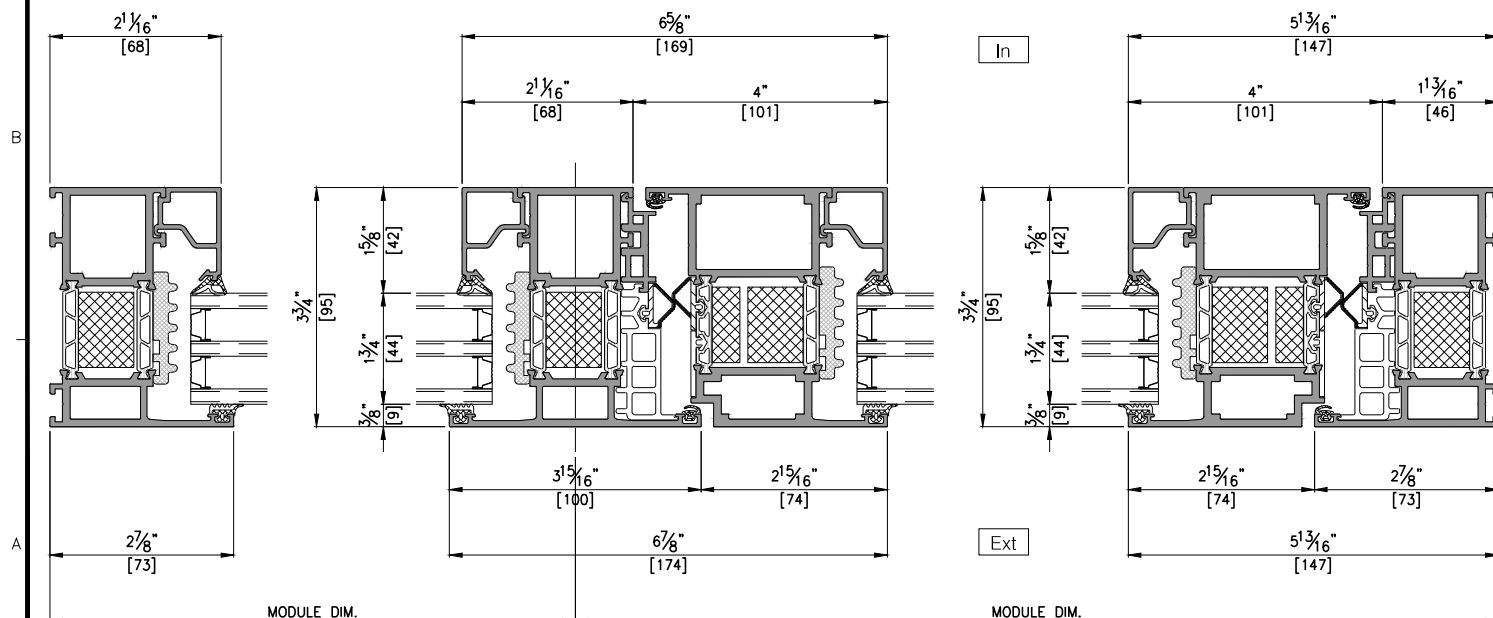

HORIZONTAL SECTION DETAIL A-A'
SCALE: 1/3

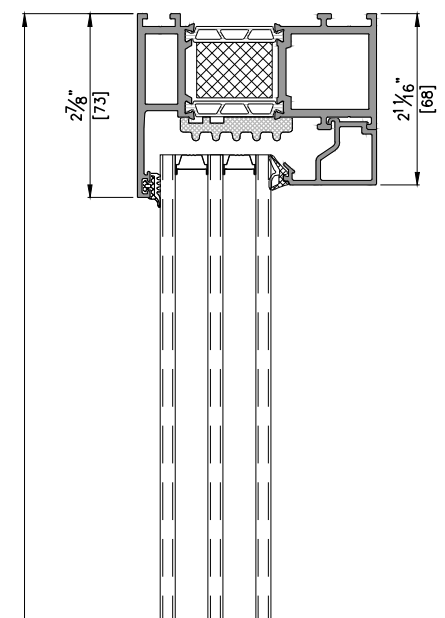

VERTICAL SECTION DETAIL B-B'
SCALE: 1/3

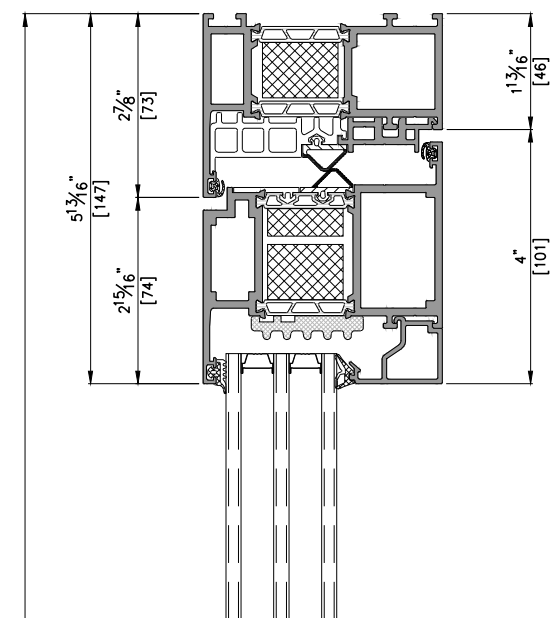

VERTICAL SECTION DETAIL C-C'
SCALE: 1/3

NOTE
OX TYPE
44mm

- General Notes
- Elevations are shown from exterior unless otherwise noted
 - Anchor/wall fastener - Location, spacing and quantity to be determined per design pressure requirements by structural engineer and/or certified test drawings

△			
△			
△			
△			
△			
0			
	2021. 00. 00.		
REV.	DESCRIPTION		
v.3			

PROJECT		-	
ITEM NO.		-	
PRODUCT NAME			
EDS95 IW NO SILL			
QTY	1		
VIEW			
EXTERIOR			
SCALE			
-			
DRAWING NO.		ISSUE	